



# PERSONAL HYGIENE

Quality equipment, securing maximum hygiene



„To be the first choice for hygienic products by developing leading solutions and providing added value while spreading our knowledge and passion for hygiene.“

#### **Conditions**

No part of this document may be copied, published or otherwise made visible without the written consent of Elpress BV. The information in this brochure has been compiled with care, and no rights may be derived from it. Articles, details and colours in the displayed images may differ from the actual products. For the most recent information, please visit our website: [www.elpress.com](http://www.elpress.com).

# TABLE OF CONTENTS

About Elpress	4
Personal Hygiene	6

## HYGIENIC ENTRANCES / STATIONS

Sole cleaning and hand disinfection	11
Sole disinfection and hand disinfection	11
Sole cleaning, shaft cleaning and hand disinfection	12
Sole cleaning, hand washing and hand disinfection	12
Sole disinfection, hand washing and hand disinfection	13
Sole cleaning, hand washing, drying and disinfection	13
Sole disinfection, hand washing, drying and disinfection	14
Double version with sole cleaning and/or sole disinfection	15
Hygiene stations	16

## HAND CLEANING

Single wash basins	25
Was basins	26
Double wash basins	27
Wash basins with hand dryer	28
Single wash basins with accessories	28

## CHEMICAL DISPENSERS

Chemical dispensers with access control	31
Chemical dispensers	32

## SOLE CLEANING

Sole cleaners	35
Sole and shoe side cleaners	36
Sole and shaft cleaners	37

## SOLE DISINFECTION

Sole disinfection	42
-------------------	----

## HYGIENE ACCESSORIES

Soap dispensers	44
Paper dispensers	44
Disposable dispensers	45
Paper baskets and bins	45
Waste bins, waste bag holders and toilet roll holders	46
Hand dryers	47
Knife holders and sterilisers	47
Hygiene accessories	48
Apron wash places	49

## DRYING AND STORAGE RACKS

Boot dryers	53
Boot storage racks	54
Apron racks	56

## SOCIAL ROOM EQUIPMENT

Access control	58
Benches	60
Clothes cabinets and wardrobe	62

# ABOUT ELPRESS

Since 1976  for hygiene

Elpress is the leading producer in the field of industrial hygiene. Our focus is on the delivery of total solutions: customer-focused systems that are expertly integrated into your business process. By simplifying processes and sharing knowledge, we can add value to your business with a complete product package.

## INNOVATING FOR MORE THAN **45 YEARS**

Elpress has been in the business of innovating for more than forty-five years. We strive constantly to maintain our lead in market development by addressing the most divergent questions of hygiene in a highly inventive and successful way. We are proud to say that a number of our products are now viewed as the benchmark in our industry. We can only meet this high level of innovation by having a

balanced team of professionals, who cover all possible disciplines, and above all by listening carefully to your requirements. In this way, we are in a position to develop, produce, deliver and maintain efficient hygiene solutions.



Global  
availability



Total  
supplier



Made in  
The Netherlands



Innovative  
organisation



Over 45 years  
of experience

## OUR PRODUCT GROUPS

### WE ARE A TOTAL SUPPLIER

Our strength is that we are a total supplier; a single partner for all your hygiene-related affairs.



#### Personal Hygiene

Efficient personal hygiene cannot be underestimated, especially not in production environments where contamination via people is a risk factor.



#### Cleaning Systems

Our cleaning systems are extremely efficient, thrifty in the use of water and power, low maintenance and easy to operate.



#### Industrial Washing Systems

Our industrial washing systems let you clean load carriers, crates, pallets or boxes. For an efficient way to handle costs and the environment.



#### Components

Whether it's a high-pressure gun, spray nozzle or cleaning hose, our complete product range enables us to offer you a solution for every challenge.



#### Drainage

Elpress drains and gutters are of excellent and proven quality. The rounded shapes and smooth finish ensure that the water and dirt are removed without impediment.



#### Mechanical Handling Systems

The various lifts and tippers are designed to relieve your employees from having to do heavy lifting and are ideal for the accelerated emptying of load carriers.

# EFFICIENT PERSONAL HYGIENE

## FUNCTIONAL, HIGH-QUALITY AND HYGIENICALLY DESIGNED

Efficient personal hygiene can not be underestimated, especially in production environments where the risk of contamination poses great danger. Whether it's a wash basin, apron cleaner or a built-in hygienic entrance, our complete product range enables us to offer you a solution for every challenge. Systems produced in-house with an Elpress feel; functional, high-quality and hygienically designed.

**The 5 key elements of Personal Hygiene** In the food industry, there is a lot of contact between employees and food. It is therefore important for the clothing and bodies of employees to be extremely hygienic. After all, you don't want dirt and bacteria finding their way into the food. Working in a hygienic manner avoids contamination and lets you avoid all risks as a manufacturer. Within the field of personal hygiene, there are 5 important elements:

### 1 Soaping and washing hands

Washing the hands is the first important step in personal hygiene. Thorough cleaning removes micro-organisms.

### 2 Drying hands

To be sure that micro-organisms are removed, drying the hands is just as important. This can be done with an electric hand dryer or with paper towels.

### 3 Disinfecting hands

Research has shown that a combination of washing and disinfecting the hands is the best way to remove most of the micro-organisms present on them

### 4 Cleaning / Disinfecting soles

Footwear carries visible and invisible dirt. A disinfectant is used to remove invisible micro-organisms. This is done through active cleaning with brushes or by walking through a disinfection bath.

### 5 Access control

The access control requires one or more actions to be completed before a worker can proceed to the next section or area. An access control requires employees to act hygienically, which helps improve hygiene standards.



START THE SCAN



### A customised hygiene configuration

Setting up a hygienic area is a process that is closely coordinated to the needs and wishes of each organisation. That is why Elpress products are particularly diverse and effective.

We would be happy to work with you to create a total concept for your company to ensure that you're ready to start work in the most hygienic way possible to suit your situation and budget. Factors that play a role in putting together a customised hygiene configuration include:

- Number of users
- Required hygiene elements
- Available space
- Budget

### Hygiene Selector

Do you want to know which hygiene entrance layout best suits your business? Then fill in the Hygiene Selector. Five steps show you in a quick and easy way what your hygiene entrance has to comply with. You will be sent no obligation advice about a hygiene entrance for your company.

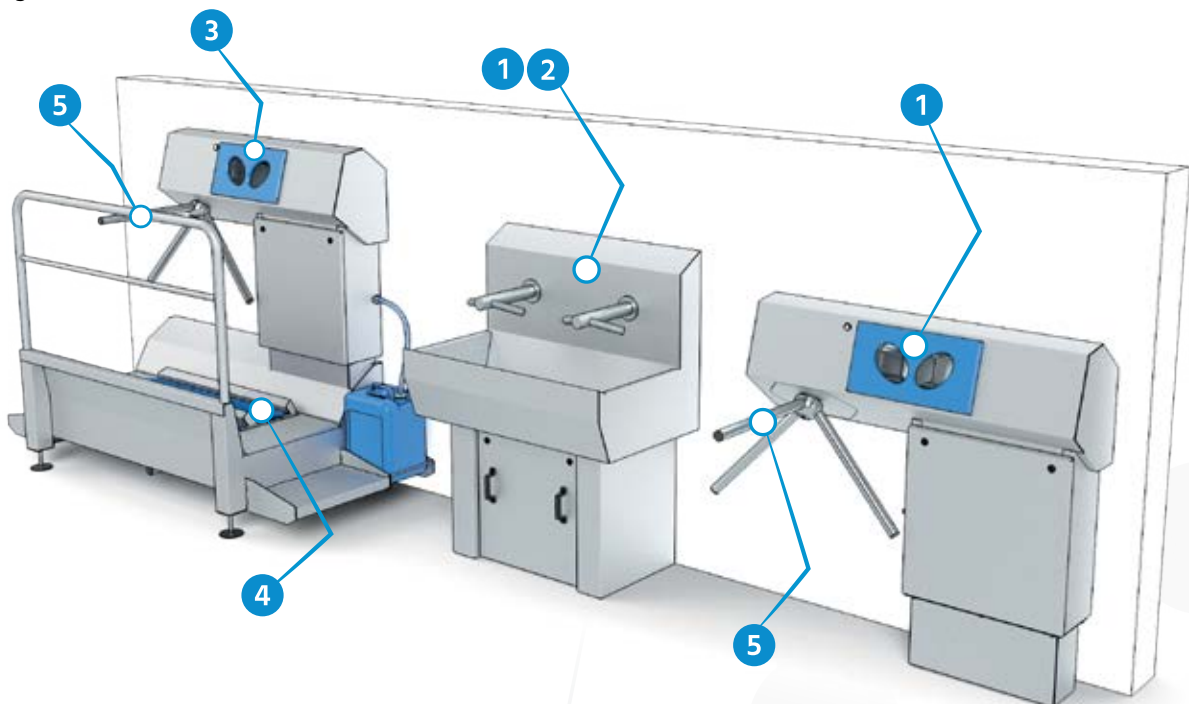
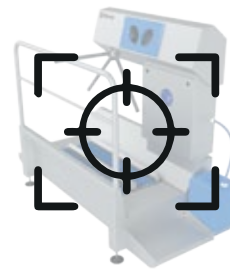

# ELPRESS QUALITY, MADE IN HOLLAND

## EXTREMELY SMART HYGIENE PRODUCTS

Do you want to increase levels of personal hygiene in your company? You can with the products from Elpress. Our products are designed right down to the details. We would be happy to work with you to create a total concept for your company to ensure that you're ready to start work in the most hygienic way possible.

"Given the size of our poultry slaughterhouse in Maasmechelen, our challenge was to find a hygiene solution that let our staff pass through quickly. Right from the outset, Elpress left a strong impression as an adviser."

**Marcel van den Heuvel**





## Service

Service is our keyword. Because even after you invest in our products, we continue working with you. We have the equipment and knowledge required for maintenance and/or repairs. This enables us to provide you with optimal disposal in the short and long term. A complete package of solutions, always with a strong focus on you as our customer.

## HACCP International certified

Elpress is the first, and so far the only,



manufacturer of hygienic entrances in the world whose products are independently recognised for supporting your HACCP environment.

## 4-year warranty on sole brushes

Our brushes are made from food-safe, robust materials. The quality of these brushes is confirmed daily by dozens of companies. We provide a full warranty of four years on our brushes as standard.

**4 Years**  
Warranty  
on brushes

## LEGEND

	Available as an integrated model
	Connectable to centralised chemical supplies
	Connectable to time and person registration
	Available as a left version
	Available as a right version
	Certified by HACCP International
	4-year warranty on brushes
	Adjustable turnstile release time
	Adjustable parameters
	Automatic rinsing
	Made of stainless steel
	Duration of operation in seconds
	Available with double rail support
	Available with ozone treatment
	Available with heating
	Adjustable feet
	Available as mobile version
	Double version
	Available with glove holder

# HYGIENIC ENTRANCES / STATIONS

## Sustainable and innovative hygienic entrances

Our hygienic entrances are made from stainless steel with a **low surface roughness**, which ensures less contamination and better cleanability. In addition, our environmentally friendly hygienic entrances have few seams and gaps for a **perfect hygienic finish**. The innovation in our products thus begins right with the hygienic design of the product itself.

## Personal hygiene with access control

The food-safe hygienic entrances can clean the soles of footwear and disinfect the hands at the same time, allowing your personnel to **pass through the cleaning process quickly and efficiently**, thus saving time. A turnstile ensures that a hygiene check takes place before the employees enter the production area. Selectable checks cover the washing and disinfecting of both hands and the length of the contact time. An access control offers you many advantages.

## Available as a right or left version

Our hygienic entrances are available in both right and left versions. In the right-hand version, the hygiene components, such as the disinfection cylinders, are on the right-hand side. The reverse is true for the left-hand version. This flexibility lets you take account of the setup, where, for example, a mirrored back-to-back setup is possible for the installation of multiple entrances.

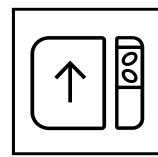

Right-hand version (R)

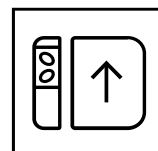

Left-hand version (L)

## THESE PRODUCTS ARE:

- Available as an integrated model
- Connectable to centralised chemical supplies
- Connectable to a person or time registration system



## SOLE CLEANING AND HAND DISINFECTION

### DZW-HDT



The DZW-HDT does two things at once: it cleans the soles and disinfects the hands. After the hands have been disinfected, the turnstile is released and the employee can proceed to the next area.



DZW-HDT-1000-R

Type	DZW-HDT-500-R/L	DZW-HDT-700-R/L	DZW-HDT-1000-R/L	DZW-HDT-1500-R/L
Article number (R)	83201980	83202000	83202040	83202080
Article number (L)	83201990	83202020	83202060	83202100
Width / mm	901	918	918	918
Height / mm	1846	1513	1513	1513
Length / mm	1493	1825	2125	2640
Brush length / mm	500	700	1000	1500
Voltage / VAC	3x 380-400	3x 380-400	3x 380-400	3x 380-400
Frequency / Hz	50-60	50-60	50-60	50-60
Power / kW	1	1	1	1

## SOLE DISINFECTION AND HAND DISINFECTION

### DZD-HDT



The DZD-HDT does two things at once: it disinfects the soles and disinfects the hands. After the hands have been disinfected, the turnstile is released and the employee can proceed to the next area.



DZD-HDT-1000-R

Type	DZD-HDT-500-R/L	DZD-HDT-1000-R/L	DZD-HDT-1500-R/L
Article number (R)	83203080	83203000	83203040
Article number (L)	83203090	83203020	83203060
Width / mm	908	948	948
Height / mm	1590	1247	1247
Length / mm	973	1919	2434
Disinfection bath / ltr	26	34	37
Voltage / VAC	1x 230	1x 230	1x 230
Frequency / Hz	50-60	50-60	50-60
Power / kW	0.5	1	1

## SOLE CLEANING, SHAFT CLEANING AND HAND DISINFECTION

### DZW-HDT-EDSW

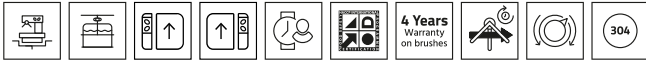

The DZW-HDT-EDSW is a hygienic entrance which cleans the soles and disinfects the hands at the same time. This means your personnel can proceed quickly and efficiently through the cleaning process. When using the shaft cleaner, the sides and shafts of the boots are cleaned.

Type	DZW-HDT-EDSW-500-R/L
Article number (R)	83202019
Article number (L)	83202017
Width / mm	908
Height / mm	1247
Length / mm	2207
Brush length / mm	500
Voltage / VAC	3x 380-400
Frequency / Hz	50-60
Power / kW	2



DZW-HDT-EDSW-500-R

## SOLE CLEANING, HAND WASHING AND HAND DISINFECTION

### SANICARE-B



With the SANICARE-B, you stand on the cleaning brushes while you wash your hands. You can optionally dry your hands with paper and then disinfect your hands in the disinfection cylinders. After the hands have been disinfected, the turnstile is released and the employee can proceed to the next area.

Type	SANICARE-500-B-R/L	SANICARE-1000-B-R/L	SANICARE-1500-B-R/L
Article number (R)	83203940	83204000	83204040
Article number (L)	83203920	83204020	93204060
Width / mm	908	948	948
Height / mm	1237	1364	1364
Length / mm	973	1919	2434
Brush length / mm	500	1000	1500
Voltage / VAC	3x 380-400	3x 380-400	3x 380-400
Frequency / Hz	50-60	50-60	50-60
Power / kW	1	1	1



SANICARE-1000-B-R with optional paper dispenser and paper basket.

## SOLE DISINFECTION, HAND WASHING AND HAND DISINFECTION

### SANICARE-D



With SANICARE-D, you stand in the disinfection bath while you wash your hands. You can optionally dry your hands with paper and then disinfect your hands in the disinfection cylinders. After the hands have been disinfected, the turnstile is released and the employee can proceed to the next area.



SANICARE-1000-D-R with optional paper dispenser and paper basket.

Type	SANICARE-1000-D-R/L	SANICARE-1500-D-R/L
Article number (R)	83204100	83204140
Article number (L)	83204120	83204160
Width / mm	948	948
Height / mm	1364	1364
Length / mm	1919	2434
Disinfection bath / ltr	34	37
Voltage / VAC	1x 230	1x 230
Frequency / Hz	50-60	50-60
Power / kW	0.5	0.5

## SOLE CLEANING, HAND WASHING, DRYING AND DISINFECTION

### SANICARE-DYSON-B



With the SANICARE-DYSON-B, you stand on the cleaning brushes while you wash your hands. You dry your hands in the Dyson Airblade™. After the hands have been disinfected, the turnstile is released and the employee can proceed to the next area.



SANICARE-DYSON-1500-B-R

Type	SANICARE-DYSON 500-B-R/L	SANICARE-DYSON 1000-B-R/L	SANICARE-DYSON 1500-B-R/L
Article number (R)	83204540	83204500	83204200
Article number (L)	83204560	83204520	83204220
Width / mm	1113	1113	918
Height / mm	1513	1630	1630
Length / mm	1825	2125	2640
Brush length / mm	500	1000	1500
Voltage / VAC	3x 380-400	3x 380-400	3x 380-400
Frequency / Hz	50-60	50-60	50-60
Power / kW	2.6	2.6	2.6

## SOLE DISINFECTION, HAND WASHING, DRYING AND DISINFECTION

### SANICARE-DYSON-D



With the SANICARE-DYSON-D, you stand in the disinfection bath while you wash your hands. You dry your hands in the Dyson Airblade™. After the hands have been disinfected, the turnstile is released and the employee can proceed to the next area.



SANICARE-DYSON-1500-D-R

Type	SANICARE-DYSON 500-D-R/L	SANICARE-DYSON 1000-D-R/L	SANICARE-DYSON 1500-D-R/L
Article number (R)	83204570	83204590	83204300
Article number (L)	83204580	83204600	83204320
Width / mm	1113	1113	918
Height / mm	1407	1524	1524
Length / mm	1608	1938	2558
Disinfection bath / ltr	28	34	37
Voltage / VAC	3x 380-400	3x 380-400	3x 380-400
Frequency / Hz	50-60	50-60	50-60
Power / kW	2.1	2.1	2.1

## SOLE CLEANING, HAND WASHING, DRYING AND DISINFECTION

### SANICARE-TAP-B



With the SANICARE-TAP-B, you stand on the cleaning brushes while you wash your hands and then dry them with the Dyson Airblade Tap™. After the hands have been disinfected, the turnstile is released and the employee can proceed to the next area.



SANICARE-TAP-1500-B-R

Type	SANICARE-TAP-1500-B-R/L
Article number (R)	83204800
Article number (L)	83204900
Width / mm	1113
Height / mm	1524
Length / mm	2640
Brush length / mm	1500
Voltage / VAC	3x 380-400
Frequency / Hz	50-60
Power / kW	2.6

## DOUBLE VERSION WITH SOLE CLEANING AND DISINFECTION

### COMBI-BD



The COMBI-BD is ideal for processing large numbers of people on a daily basis. Upon entering, the soles and hands are disinfected. During exit, the soles are cleaned and the hands are optionally disinfected (DD). Secure passage is always ensured by the turnstile.

Type	COMBI-BD-D-1500-R/L	COMBI-BD-DD-1500-R/L
Article number (R)	83205000	83205100
Article number (L)	83205020	83205120
Width / mm	1640	1640
Height / mm	1558	1558
Length / mm	2640	2640
Brush length / mm	1500	1500
Disinfection bath / ltr	37	37
Voltage / VAC	3x 380-400	3x 380-400
Frequency / Hz	50-60	50-60
Power / kW	1.5	1.5



COMBI-BD-DD-1500-R

## DOUBLE VERSION WITH SOLE CLEANING

### COMBI-BB



The COMBI-BB is ideal for processing large numbers of people on a daily basis. This hygienic entrance can be used either as a double entrance or as a double exit, with the soles being cleaned and the hands disinfected. Secure passage is always ensured by the turnstile.

Type	COMBI-BB-D-1500-R/L	COMBI-BB-DD-1500*
Article number (R)	83205200	83205300
Article number (L)	83205220	* double entrance and exit
Width / mm	1640	1640
Height / mm	1558	1558
Length / mm	2640	2640
Brush length / mm	1500	1500
Voltage / VAC	3x 380-400	3x 380-400
Frequency / Hz	50-60	50-60
Power / kW	2	2



COMBI-BB-DD-1500

## DOUBLE VERSION WITH SOLE CLEANING AND DISINFECTION

### SANICARE-DYSON-COMBI



The SANICARE-DYSON-COMBI functions as a controlled entrance and exit. Upon entering, your soles are disinfected and your hands are washed, dried and disinfected. The turnstile is released only once hand disinfection is complete. When exiting, the soles are cleaned.



SANICARE-DYSON-COMBI-BD-1500-R

Type	SANICARE-DYSON-COMBI-BD-1500-R/L
Article number (R)	83204400
Article number (L)	83204410
Width / mm	1651
Height / mm	1640
Length / mm	2640
Brush length / mm	1500
Disinfection bath / ltr	37
Voltage / VAC	3x 380-400
Frequency / Hz	50-60
Power / kW	2.7

## HYGIENE STATION

### EWG-EZR



By placing the sole of your shoe on the brush and holding the handle at the same time, the soles and sides of your shoes are cleaned. You can also wash your hands in the integrated wash basin. Optionally available with paper dispenser and paper basket.



EWG-EZR FLOOR MODEL

Type	EWG-EZR FLOOR MODEL	EWG-EZR WALL MODEL
Article number	83207070	83207075
Width / mm	1283	1283
Depth / mm	385	385
Height / mm	1565	1565
Voltage / VAC	1x 230	1x 230
Frequency / Hz	50-60	50-60
Power / kW	0.2	0.2



## HYGIENE STATION

### EWG-EZR DELUXE



By placing the sole of your shoe on the brush and holding the handle at the same time, the soles and sides of your shoes are cleaned. You can also wash your hands in the integrated wash basin. The DELUXE variant is a more robust design with integrated chemical supply and a wider brush.

Type	EWG-EZR DELUXE FLOOR MODEL	EWG-EZR DELUXE WALL MODEL
Article number	83207070-D	83207075-D
Width / mm	920	1283
Depth / mm	385	385
Height / mm	1391	1283
Voltage / VAC	3x 380-400	3x 380-400
Frequency / Hz	50-60	50-60
Power / kW	0.3	0.3



EWG-EZR DELUXE FLOOR MODEL

## HYGIENE STATION

### EWG-EZR-P



The EWG-EZR-P ensures that you can wash, disinfect and dry your hands. In addition, this hygiene station also ensures that your soles are cleaned.

Type	EWG-EZR-P
Article number	83207070-P
Width / mm	1405
Depth / mm	382
Height / mm	1442
Voltage / VAC	1x 230
Frequency / Hz	50-60
Power / kW	0.3



EWG-EZR-P

## HYGIENE STATION

### EWG-EZR-V



The EWG-EZR-V ensures that you can wash, disinfect and dry your hands. In addition, this hygiene station also ensures that your soles are cleaned. The Dyson-Airblade-V ensures that your hands are dry within 12 seconds.

Type	EWG-EZR-V
Article number	83207070-V
Width / mm	1225
Depth / mm	382
Height / mm	1442
Voltage / VAC	1x 230
Frequency / Hz	50-60
Power / kW	1.2



EWG-EZR-V

## HYGIENE STATION

### SANICARE-WM



With the SANICARE-WM, you can wash and disinfect your hands. You can optionally dry your hands with paper and then disinfect your hands in the disinfection cylinders. After the hands have been disinfected, the turnstile is released and the employee can proceed to the next area.

Type	SANICARE-WM-R/L
Article number (R)	83204700
Article number (L)	83204720
Width / mm	1368
Depth / mm	851
Height / mm	767
Voltage / VAC	1x 230
Frequency / Hz	50-60
Power / kW	0.2



SANICARE-WM-R

## HYGIENE STATION

### SANICARE



With the SANICARE, you can wash and disinfect your hands. You can optionally dry your hands with paper and then disinfect your hands in the disinfection cylinders. After the hands have been disinfected, the turnstile is released and the employee can proceed to the next area.

Type	SANICARE-R/L
Article number (R)	83204080
Article number (L)	83204090
Width / mm	1480
Depth / mm	795
Height / mm	1325
Voltage / VAC	1x 230
Frequency / Hz	50-60
Power / kW	0.2

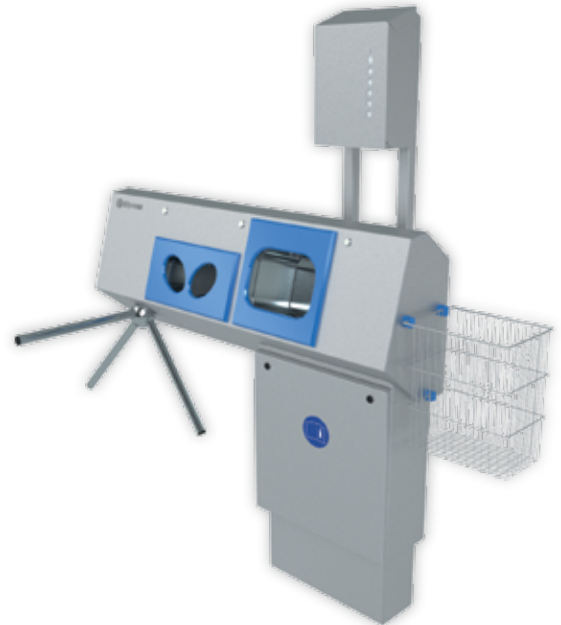

SANICARE-R with optional paper dispenser and paper basket.

## HYGIENE STATION

### SANICARE-DYSON

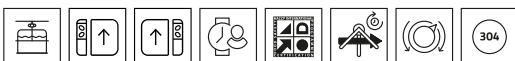

After washing your hands, you dry them in the Dyson Airblade™, after which your dry hands are disinfected. After the hands have been disinfected, the turnstile is released and the employee can proceed to the next area.

Type	SANICARE-DYSON-R/L
Article number (R)	83204240
Article number (L)	83204250
Width / mm	2640
Depth / mm	918
Height / mm	1630
Voltage / VAC	1x 230
Frequency / Hz	50-60
Power / kW	2



SANICARE-DYSON-R

## HYGIENE STATION

### SANICARE-EZR



By placing the sole of your shoe on the brush and holding the handle at the same time, your shoes are cleaned. After soaping and washing your hands, you can optionally dry them with paper and then disinfect your hands in the disinfection cylinders. After using the hand disinfectant, the turnstile is released.



SANICARE-EZR

Type	SANICARE-EZR-R/L
Article number (R)	83201115
Article number (L)	83201110
Width / mm	2175
Depth / mm	815
Height / mm	1795
Voltage / VAC	3x 380-400
Frequency / Hz	50-60
Power / kW	0.2

# HYGIENIC ENTRANCES / STATIONS



Hand disinfection



DZW-HDT-1500-L



SANICARE-WM-R



DZW-HDT-1500-R



DZW-HDT-1000-R

# HYGIENIC ENTRANCES / STATIONS



DZD-HDT-1000-R Built-in model



DZW-HDT-1000-L Built-in model



DZW-HDT-1500-R



COMBI-BB-D-1500-L



Sole cleaning with the DZW-HDT-1000-R



SANICARE-DYSON-1500-B-R



SANICARE-500-B-R



Washing hands in a SANICARE-1500-B-R

# HAND CLEANING

## Wash basins in various designs

Elpress gives you the choice of different types of sink. For example, we supply single wash basins, which are available in various designs. Our product range also includes wash troughs, which can be used by several people at once. Double back-to-back versions are also an option. All wash basins have the following advantages and/or properties:

- Ergonomically designed
- Made of stainless steel
- Automatic Flushing System (if sensor-operated)
- Water does not lie in the corners of sinks
- Enough space to wash your underarms
- Thermal mixer tap, adjustable to the desired temperature
- Connections supplied with dirt trap and non-return valve
- Hanger and siphon with odour trap supplied

## Sensor or knee operated

Elpress wash basins are available with sensor operation or knee operation. Both variants provide hands-free operation. As a result, the risk of contamination is lowered. Sensor-operated sinks need a power connection, while knee-operated sinks are controlled by a self-closing valve. In other words, knee-operated sinks can be installed without the need for an electrical connection.

## Automatic Flushing System

Our sensor-operated wash basins are equipped with an automatic rinsing cycle which works when the wash basin is not in use. Rinsing can be set to between 24 and 78 hours after the last use. Rinsing the lines in this way counteracts any accumulation of bacteria.





## SINGLE WASH BASIN WITH SENSOR OR KNEE OPERATION

### EWG-1

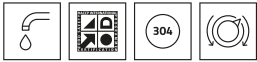

Single wash basin with sensor or knee operation

Type	EWG-1S	EWG-1K
	Sensor operated	Knee operated
Article number	83207015	83207115
Width / mm	503	503
Depth / mm	461	461
Height / mm	813	813
Voltage / VAC	1x 230	-
Frequency / Hz	50-60	-
Power / kW	0.1	-



EWG-1S

## SINGLE WASH BASIN WITH SENSOR OR KNEE OPERATION

### EWG-1 DELUXE



Single wash basin with sensor or knee operation.

The Deluxe version has a luxury rounded finish.

Type	EWG-1S DELUXE	EWG-1K DELUXE
	Sensor operated	Knee operated
Article number	83207010	83207110
Width / mm	430	430
Depth / mm	453	453
Height / mm	762	762
Voltage / VAC	1x 230	-
Frequency / Hz	50-60	-
Power / kW	0.1	-



EWG-1S DELUXE

## WASH BASINS WITH SENSOR OPERATION

### EWG-2S TO EWG-6S

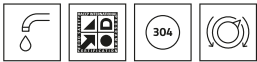

Wash basins with sensor operation.

2 to 6 wash areas.



EWG-3S with optional manual soap dispensers

Type	EWG-2S	EWG-3S	EWG-4S	EWG-5S	EWG-6S
	Sensor operated	Sensor operated	Sensor operated	Sensor operated	Sensor operated
Wash areas	2	3	4	5	6
Article number	83207020	83207030	83207040	83207050	83207060
Width / mm	975	1475	1975	2475	2975
Depth / mm	546	546	546	546	546
Height / mm	760	760	760	760	760
Voltage / VAC	1x 230	1x 230	1x 230	1x 230	1x 230
Frequency / Hz	50-60	50-60	50-60	50-60	50-60
Power / kW	0.1	0.1	0.1	0.1	0.1

## WASH BASINS WITH KNEE OPERATION

### EWG-2K TO EWG-6K



Wash basins with knee operation.

2 to 6 wash areas.



EWG-3K

Type	EWG-2K	EWG-3K	EWG-4K	EWG-5K	EWG-6K
	Knee operated	Knee operated	Knee operated	Knee operated	Knee operated
Article number	83207120	83207130	83207140	83207150	83207160
Wash areas	2	3	4	5	6
Width / mm	975	1475	1975	2475	2975
Depth / mm	546	546	546	546	546
Height / mm	760	760	760	760	760

## DOUBLE WASH BASINS WITH SENSOR OPERATION

### EWG-2S-D TO EWG-6S-D



Double wash basins with sensor operation.

4 to 12 wash areas.



EWG-3S-D

Type	EWG-2S-D	EWG-3S-D	EWG-4S-D	EWG-5S-D	EWG-6S-D
	Sensor operated	Sensor operated	Sensor operated	Sensor operated	Sensor operated
Article number	83207220	83207230	83207240	83207250	83207260
Wash areas	4	6	8	10	12
Width / mm	975	1475	1975	2475	2975
Depth / mm	1179	1179	1179	1179	1179
Height / mm	1342	1342	1342	1342	1342
Voltage / VAC	1x 230	1x 230	1x 230	1x 230	1x 230
Frequency / Hz	50-60	50-60	50-60	50-60	50-60
Power / kW	0.1	0.1	0.1	0.1	0.1

## DOUBLE WASH BASINS WITH KNEE OPERATION

### EWG-2K-D TO EWG-6K-D



Double wash basins with knee operation.

4 to 12 wash areas.



EWG-3K-D

Type	EWG-2S-D	EWG-3S-D	EWG-4S-D	EWG-5S-D	EWG-6S-D
	Knee operated	Knee operated	Knee operated	Knee operated	Knee operated
Article number	83207120	83207130	83207140	83207150	83207160
Wash areas	4	6	8	10	12
Width / mm	975	1475	1975	2475	2975
Depth / mm	1179	1179	1179	1179	1179
Height / mm	1342	1342	1342	1342	1342

## WASH BASINS WITH HAND DRYER

### EWG-1S-TAP TO EWG-6S-TAP

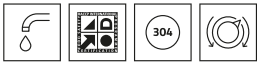

Wash basins with sensor tap and hand dryer in one. After washing your hands, the Dyson Airblade Tap hand dryer delivers a powerful stream of air to dry them.



EWG-2S-TAP

Type	EWG-1S-TAP	EWG-2S-TAP	EWG-3S-TAP	EWG-4S-TAP	EWG-5S-TAP	EWG-6S-TAP
	Sensor operated	Sensor operated	Sensor operated	Sensor operated	Sensor operated	Sensor operated
Wash areas	1	2	3	4	5	6
Article number	83207410	83207420	83207430	83207440	83207450	83207460
Width / mm	503	1003	1503	2003	2503	3003
Depth / mm	615	615	615	615	615	615
Height / mm	1290	1290	1290	1290	1290	1290
Voltage / VAC	1x 230	1x 230	1x 230	1x 230	1x 230	1x 230
Frequency / Hz	50-60	50-60	50-60	50-60	50-60	50-60
Power / kW	1.6	3.2	4.8	6.4	8	9.6

## SINGLE WASH BASIN WITH ACCESSORIES

### EWG HYGIENE WALL



Fully sensor-controlled single wash basin mounted on a stainless steel wall. The hygiene wall includes a paper dispenser and paper basket.



EWG HYGIENE WALL

Type	EWG HYGIENE WALL
	Sensor operated
Article number	83207081
Wash areas	1
Width / mm	1000
Depth / mm	530
Height / mm	1063
Voltage / VAC	1x 230
Frequency / Hz	50-60
Power / kW	0.1

# HAND CLEANING



EWG-4S with soap dispensers



EWG-1S Deluxe



EWG-4S-TAP



EWG-4S-D



EWG- 2S with soap dispensers

# CHEMICAL DISPENSERS

## How does a chemical dispenser work?

A chemical dispenser is filled with disinfectant or soap and is located just outside your production area.

It works as follows:

- Insert your hands into the cylinders.
- Sensors activate the atomisation of the disinfectant or the dosing of soap.
- The turnstile is released.
- Free passage is enabled.

## Wall or floor mounting

Chemical dispensers are available as a wall or floor-mounted model.

The wall-mounted model can be easily mounted on the wall.

## Advantages of Elpress chemical dispensers

Our chemical dispensers have various advantages:

- Space for 5 litres of chemical, which means it does not have to be constantly topped up.
- A level indicator, so that you know exactly when it's time to top up.
- Possibility to set the duration of the chemical dosing yourself. That lets you determine the duration of the atomisation.
- The release time of the turnstile can also be set.
- A wall model can optionally be placed on a floor-mounted frame. The chemical dispensers are also to be installed with rail support.



## CHEMICAL DISPENSER WITH ACCESS CONTROL

### HDT / HST



The HDT / HST is an automatic dispenser. When the hands are inserted into the cylinders, sensors activate the atomisation of the disinfectant or the dosing of soap. After this, the turnstile is released and one can proceed.

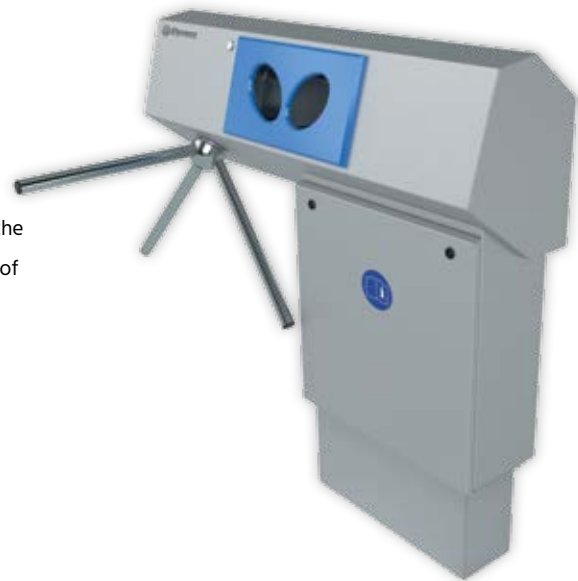

HDT-R / HST-R

Type	HDT-R/L	HST-R/L
	Disinfectant	Soap
Article number (R)	83201050	83201055
Article number (L)	83201060	83201065
Width / mm	1455	1455
Depth / mm	791	791
Height / mm	1207	1207
Voltage / VAC	1x 230	1x 230
Frequency / Hz	50-60	50-60
Power / kW	0.1	0.1

## CHEMICAL DISPENSER WITH ACCESS CONTROL

### HDT-WM / HST-WM



The HDT-WM/ HST-WM is an automatic dispenser in a wall model. When the hands are inserted into the cylinders, sensors activate the atomisation of the disinfectant or the dosing of soap. After this, the turnstile is released and one can proceed.



HDT-WM-R / HST-WM-R

Type	HDT-WM-R/L	HST-WM-R/L	FLOOR-MOUNTING FRAME
	Disinfectant	Soap	-
Article number (R)	83201000	83201005	83201070
Article number (L)	83201010	83201015	83201070
Width / mm	890	890	400
Depth / mm	817	817	230
Height / mm	1229	1229	1471
Voltage / VAC	1x 230	1x 230	-
Frequency / Hz	50-60	50-60	-
Power / kW	0.1	0.1	-

## CHEMICAL DISPENSER

### HD-WM / HS-WM



The HD-WM/ HS-WM is an automatic dispenser. When the hands are inserted into the cylinders, sensors activate the atomisation of the disinfectant or the dosing of soap.



HD-WM / HS-WM

Type	HD-WM	HS-WM	FLOOR-MOUNTING FRAME
	Disinfectant	Soap	-
Article number	83201020	83201025	83201070
Width / mm	721	721	400
Depth / mm	339	339	230
Height / mm	1229	1229	1471
Voltage / VAC	1x 230	1x 230	-
Frequency / Hz	50-60	50-60	-
Power / kW	0.1	0.1	-

## (MOBILE) CHEMICAL DISPENSER

### EHI



The EHI is an automatic dispenser for hand disinfectant containing alcohol. When the hands are inserted into the cylinders, sensors activate the atomisation of the disinfectant. Can be easily moved around with the optional mobile frame.



EHI on MOBILE FRAME.

Type	EHI	MOBILE FRAME
	Disinfectant or soap	-
Article number	83201400	83201410
Width / mm	210	550
Depth / mm	210	400
Height / mm	900	1520
Voltage / VAC	1x 230	-
Frequency / Hz	50-60	-
Power / kW	0.1	-



# CHEMICAL DISPENSERS



HDT-L and HDT-R



HDT-WM-L on floor-mounting frame



HDT-L and HDT-R connected to person and time registration system



HDT-R



HDT-R

# SOLE CLEANING

## Effective and practical

Elpress supplies sole cleaners in a wide range of designs which are suitable for shoes, clogs and boots. We make a distinction between three elements:

- Soles
- Sides
- Shafts

In the most complete version, both the **soles, the shoe sides and the shafts** are cleaned for maximum hygiene.

## Advantages of Elpress sole cleaners

- 4-year warranty on brushes
- Manual or automatic sensor operation
- Hygienic construction and surface finish
- The right model for every situation
- Reduces risk of contamination
- Ergonomically designed

**4 Years**  
Warranty  
on brushes

## WALKTHROUGH SOLE CLEANER

### DZW



Users walk across the DZW while the soles are cleaned by the rotating brushes. As the user walks through, the rotating brushes are automatically humidified and activated by means of sensors in both directions.

Type	DZW-1000-R/L	DZW-1500-R/L
Article number (R)	83202200	83202240
Article number (L)	83202220	83202260
Width / mm	890	890
Height / mm	1286	1286
Length / mm	2125	2640
Brush length / mm	1000	1500
Voltage / VAC	3x 380-400	3x 380-400
Frequency / Hz	50-60	50-60
Power / kW	1	1



DZW-1000-R

## SOLE CLEANERS

### EZW

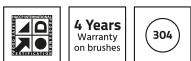

By placing the sole of your shoe on the brush and holding the handle at the same time, the sole is cleaned. The EZW works via a sensor on the handle. The unit is compact and therefore fits easily into smaller spaces.

Type	EZW
Article number	83206020
Width / mm	507
Depth / mm	545
Height / mm	898
Voltage / VAC	1x 230
Frequency / Hz	50-60
Power / kW	0.37



EZW

## WALKTHROUGH SOLE AND SHOE SIDE CLEANER

### EDZW



Upon entering the unit, sensors automatically activate the rotation of the brushes and your soles and shoe sides are cleaned. The walkthrough principle saves cleaning time.

Type	EDZW
Article number	83206015
Width / mm	890
Height / mm	1286
Length / mm	1645
Voltage / VAC	3x 380-400
Frequency / Hz	50-60
Power / kW	0.9



EDZW

## SOLE AND SHOE SIDE CLEANER

### EZR



When you place the sole of your shoe on the brush and hold the handle at the same time, the sole and shoe sides are cleaned. The brushes activate via a button on the grip. The EZR is also available as a wall model (EZR-WM).

Type	EZR	EZR-WM
Article number	83206030	83206040
Width / mm	471	471
Depth / mm	408	245
Height / mm	920	830
Voltage / VAC	1x 230	3x 380-400
Frequency / Hz	50-60	50-60
Power / kW	0.3	0.3



EZR

## SOLE AND SHOE SIDE CLEANER

### EZR-DELUXE



The more rugged EZR-DELUXE has the properties of the EZR plus a number of extra advantages. The jerrycan holder is integrated into the frame, the brush is wider and the DELUXE version has adjustable feet. The EZR-DELUXE is also available as a wall model (EZR-DELUXE-WM).

Type	EZR-DELUXE	EZR-DELUXE-WM
Article number	83206030-D	83206040-D
Width / mm	697	697
Depth / mm	472	472
Height / mm	1186	1186
Voltage / VAC	1x 230	3x 380-400
Frequency / Hz	50-60	50-60
Power / kW	0.3	0.3



EZR DELUXE

## WALKTHROUGH SHAFT CLEANER

### EDSW



Upon entering the unit, sensors automatically activate the rotation of the brushes and the shafts of your boots are cleaned.

Type	EDSW
Article number	83206005
Width / mm	890
Height / mm	1286
Length / mm	1645
Voltage / VAC	3x 380-400
Frequency / Hz	50-60
Power / kW	0.75



EDSW

## WALKTHROUGH SOLE AND SHAFT CLEANER

### EDLW



When entering the unit, sensors activate the automatic rotation of the brushes and your soles and shafts are cleaned.

Type	EDLW
Article number	83206000
Width / mm	890
Height / mm	1286
Length / mm	1645
Voltage / VAC	3x 380-400
Frequency / Hz	50-60
Power / kW	0.9



EDLW

## WALKTHROUGH SOLE AND SHAFT CLEANER

### DZSW



Upon entering the unit, sensors automatically activate the rotation of the brushes and your soles and shafts are cleaned. The DZSW is ideally suited for the cleaning and disinfection of heavily soiled boots.

Type	DZSW
Article number	83202290
Width / mm	890
Height / mm	1200
Length / mm	2225
Voltage / VAC	3x 380-400
Frequency / Hz	50-60
Power / kW	1.5



DZSW

## SOLE AND MANUAL SHAFT CLEANER

### ELZW



4 Years  
Warranty  
on brushes



By placing the sole of your shoe on the brush and holding the handle at the same time, the sole is cleaned. The ELZW works via a sensor on the handle. You can clean the shafts manually using the ergonomic brush. The unit is compact and therefore fits easily into smaller spaces.

Type	ELZW
Article number	83206010
Width / mm	507
Depth / mm	545
Height / mm	898
Voltage / VAC	1x 230
Frequency / Hz	50-60
Power / kW	0.4



ELZW

## SOLE AND SHAFT CLEANER

### EZSW



4 Years  
Warranty  
on brushes



When you place the sole of your shoe on the brush and hold the handle at the same time, the sole and shoe sides are cleaned. The brushes activate via a sensor on the grip.

Type	EZSW
Article number	83206050
Width / mm	643
Depth / mm	638
Height / mm	1062
Voltage / VAC	1x 230
Frequency / Hz	50-60
Power / kW	0.6



EZSW

# SOLE CLEANING



EZR-DELUXE



EDSW Built-in model



EZR



EZR



DZW-1500-R





DZW-1000-R Built-in model



Brushes of sole cleaner DZW-1000-R

# SOLE DISINFECTION

## Advantages of Elpress disinfection baths

The disinfection bath is filled with chemical and the soles come into contact with the disinfectant as the user walks through. In the case of the DZD, the bath is automatically refreshed, which prevents excessive use of chemical.

- Automatically refreshed
- Economic use of chemicals
- Drip-off zone
- Hygienic finish, few seams and gaps

## WALKTHROUGH SOLE DISINFECTION BATH

### DZD



The DZD disinfects soles by means of a disinfection bath. The bath is automatically topped up with disinfectant and automatically refreshed after 25 passes.



DZD-1000-R

Type	DZD-1000-R/L	DZD-1500-R/L
Article number (R)	83203100	83203140
Article number (L)	83203120	83203160
Width / mm	901	901
Height / mm	1180	1180
Length / mm	1820	2335
Disinfection bath / ltr	34	37
Voltage / VAC	1x 230	1x 230
Frequency / Hz	50-60	50-60
Power / kW	0.1	0.1

## WALKTHROUGH SOLE DISINFECTION BATH

### DISINFECTION BATH



In addition to the DZD, Elpress also has a simpler version of disinfection bath. The bath is to be filled by hand and can be emptied by removing the stopper. The disinfection bath is also available as an integrated model.



DISINFECTION BATH

Type	DESINFECTIEBAD-1200
Article number (L)	83203180
Width / mm	840
Height / mm	175
Length / mm	1200



DZD-1000-R



DZD-1000-L

# HYGIENE ACCESSORIES

## Setting up and accessories

Alongside an extensive range of hygiene equipment, such as hygienic entrances and wash basins, Elpress also offers a range of matching accessories, including dispensers, paper baskets, soap dispensers, paper dispensers, waste bag holders and jerrycan trays.

## HYGIENE ACCESSORIES

### SOAP DISPENSERS



Type	Plastic soap dispenser	Infrared soap dispenser	Stainless steel soap dispenser
Article number	78001220	78001230	78001201
Width / mm	115	110	92
Depth / mm	115	110	80
Height / mm	250	265	335
Capacity / ml	900	900	1000

## HYGIENE ACCESSORIES

### PAPER DISPENSERS



Type	Folded paper dispenser	Paper roll dispenser
Article number	78002015	78001301
Width / mm	270	278
Depth / mm	135	250
Height / mm	350	408
Capacity	600 sheets of folded paper	ø200 mm paper roll

## HYGIENE ACCESSORIES

### DISPENSERS



Type	Disposable dispenser	Disposable dispenser	Universal dispenser
Article number	78002005	78002003	78001295
Width / mm	280	140	280
Depth / mm	135	135	280
Height / mm	400	400	280
Capacity	15 litres	7.5 litres	20 litres

## HYGIENE ACCESSORIES

### DISPENSERS



Type	Glove dispenser	Glove dispenser	Apron dispenser
Article number	78001296	78001297	78002294
Width / mm	250	530	530
Depth / mm	100	100	70
Height / mm	400	300	200
Capacity	3 packs of gloves	4 packs of gloves	Suitable for scouring aprons

## HYGIENE ACCESSORIES

### PAPER BASKETS



Type	Open paper basket	Closed paper basket	Closed paper basket
Article number	78001325	78001307	78001307-1
Width / mm	350	350	400
Depth / mm	250	250	400
Height / mm	400	450	750
Capacity	35 litres	40 litres	120 litres

## HYGIENE ACCESSORIES

### WASTE BINS



Type	Waste bin with swing lid	Waste bin with foot pedal	Waste bin with foot pedal
Article number	78002355	78001265	78001267
Width / mm	410	475	475
Depth / mm	310	400	400
Height / mm	750		
Capacity	40 litres	60 litres	120 litres

## HYGIENE ACCESSORIES

### WASTE BAG HOLDERS



Type	Waste bag holder	Waste bag holder, wall model
Article number	78001303	78001311
Width / mm	530	355
Depth / mm	650	550
Height / mm	950	185
Capacity	120 litres	120 litres

## HYGIENE ACCESSORIES

### TOILET ROLL HOLDERS



Type	Toilet roll holder	Toilet roll holder
Article number	78001270	78001275
Width / mm	125	120
Depth / mm	130	135
Height / mm	80	395
Capacity	1 toilet roll	3 toilet rolls

## HYGIENE ACCESSORIES

### MISCELLANEOUS

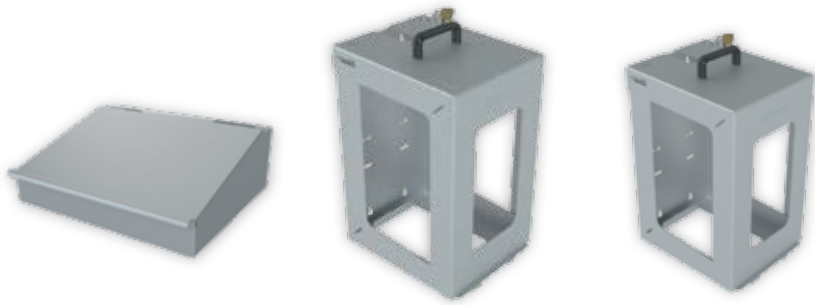

Type	Wall lectern	Jerrycan holder 20 litres	Jerrycan holder 5 litres
Article number	78001308	83207009	83206999
Width / mm	600	415	
Depth / mm	500	265	
Height / mm	100/200	310	
Capacity	including storage compartment	for 20 litre jerrycans	for 5 litre jerrycans

## HYGIENE ACCESSORIES

### HAND DRYERS



Type	Dyson Airblade V™	Dyson Airblade V™	Dyson Airblade 9KJ™
	White plastic	Sprayed nickel plastic	Stainless steel
Article number	78002002	78002002-1	78002029
Width / mm	234	234	450
Depth / mm	100	100	100
Height / mm	394	394	500

## HYGIENE ACCESSORIES

### KNIFE BASKETS



Type	MHB-1-4	MHB-2-6	MHB-3-5
Article number	78002277	78002278	78002279
Width / mm	265	170	170
Depth / mm	100	70	70
Height / mm	500	490	490
Capacity	5 knives, 1 sharpening steel and 1 glove tensioner	12 knives and 2 sharpening steels	10 knives, 2 sharpening steels and 1 glove tensioner

## HYGIENE ACCESSORIES

### KNIFE STERILISER



The H010 has capacity for either 4 knives or 12 sharpening steels, with built-in boil-dry safeguard. The thermostatic control ensures a constant and accurate temperature. The unit is also designed for easy wall mounting.



H010

Type	H010
Article number	78002285
Width / mm	200
Depth / mm	193
Height / mm	490
Capacity	4 knives or 12 sharpening steels

## HYGIENE ACCESSORIES

### GLOVE PRE-CLEANER



When you put your hand including butcher's gloves into the cleaner for butcher's gloves, a sensor activates the cleaning process and cleaning with pressurised water takes place. The EHW needs to be connected to a maximum 40 bar externally supplied water pressure.

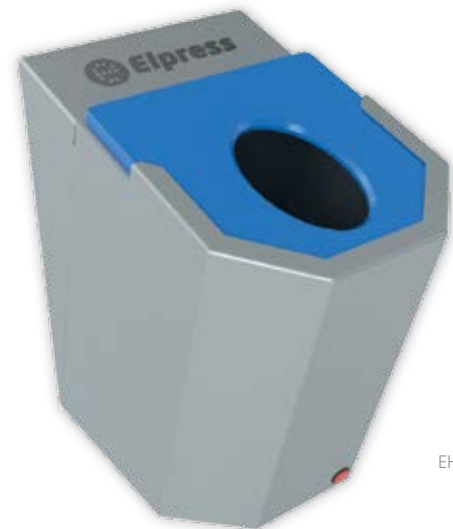

EHW

Type	EHW
Article number	78002275
Width / mm	300
Depth / mm	530
Height / mm	665
Voltage / VAC	1x 230
Frequency / Hz	50-60
Power / kW	0.1



## HYGIENE ACCESSORIES

### BRUSH CLEANER

304

With the help of the cleaning gun and the flexible hose, you can clean various Elpress sole brushes. The water can be drained away using the ball valve mounted to the underside of the cleaning station. The brush cleaning station can also be used as a soaking bath to remove dirt.



BRUSH CLEANING STATION 1000

Type	BRUSH CLEANING STATION 1000	BRUSH CLEANING STATION 1500
Article number	78002407	78002408
Width / mm	1230	1730
Depth / mm	584	584
Height / mm	850	850
Suitable for	Brushes up to 1000 mm	Brushes up to 1500 mm

## APRON WASH PLACE

### SWP

304

The apron wash place is suitable for manually cleaning aprons using a brush with water supply and spray gun. Boots can also be cleaned by placing them on the floor grate.



SWP

Type	SWP
Article number	78000350
Width / mm	1277
Depth / mm	454
Height / mm	1800

## APRON WASH PLACE WITH SOLE CLEANER

### SWP-EZW



The apron wash place is suitable for manually cleaning aprons using a brush with water supply and spray gun. Soles can also be automatically cleaned with the built-in sole cleaner.

Type	SWP-EZW
Article number	78000351
Width / mm	1588
Depth / mm	589
Height / mm	1816
Voltage / VAC	1x 230
Frequency / Hz	50-60
Power / kW	0.3



# HYGIENE ACCESSORIES



Soap dispenser



SWP



Glove dispensers



Paper dispenser for paper roll



Universal and disposable dispensers

# DRYING AND STORAGE RACKS

## Fast drying of boots, shoes and clogs with a boot dryer

A boot dryer lets you avoid a mess on the shop floor or in the staff lounge. All boots, shoes and clogs can be efficiently stored on the rack. What's more, Elpress boot dryers are sturdy by nature, space-saving and easy to expand with multiple racks. Choose from a wall or floor model; the wall-mounted model is easy to fix to the wall. Thanks to the automatic air supply, drying takes place extra fast.

**Advantages of storage and drying racks** If hygiene matters to you, then you've come to the right place at Elpress. All our products, such as our boot racks, are specially developed for the food industry and thus have a perfect hygienic finish. We actually understand like no other that your shoes, boots or clogs need to be stored in a food-safe place to keep dirt and other bacteria out of your production area. Advantages:

- Saves space
- Made of stainless steel
- Available as a wall or floor model

## OPTIONS FOR THESE PRODUCTS:

- Air heating
- Ozone treatment
- Optional glove holder



## BOOT DRYERS

### ELD FLOOR MODEL



The boot dryers dry the inside of the boots, shoes or clogs by means of an (optionally heated) air stream. Application of the optional ozone treatment kills bacteria and neutralises odours.



ELD-20 FLOOR MODEL

Type	ELD-10	ELD-20	ELD-30	ELD-40
Article number	78000333	78000321	78000323	78000326
Capacity	10 pairs	20 pairs	30 pairs	40 pairs
Width / mm	870	1306	1826	2346
Depth / mm	380	380	380	380
Height / mm	1840	1840	1840	1840
Voltage / VAC	1x 230	1x 230	1x 230	1x 230
Frequency / Hz	50-60	50-60	50-60	50-60
Power / kW	Depending on options	Depending on options	Depending on options	Depending on options

## BOOT DRYERS

### ELD WALL MODEL

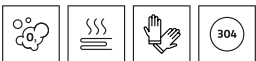

The boot dryers dry the inside of the boots, shoes or clogs by means of an (optionally heated) air stream. Application of the optional ozone treatment kills bacteria and neutralises odours.

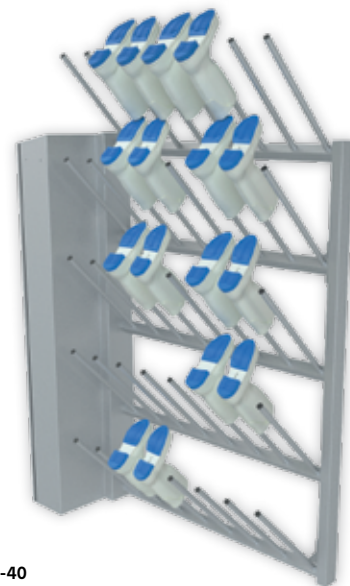

ELD-20 WALL MODEL

Type	ELD-10	ELD-20	ELD-30	ELD-40
Article number	78000332	78000320	78000322	78000324
Capacity	10 pairs	20 pairs	30 pairs	40 pairs
Width / mm	870	1286	1806	2326
Depth / mm	400	400	400	400
Height / mm	1840	1840	1840	1840
Voltage / VAC	1x 230	1x 230	1x 230	1x 230
Frequency / Hz	50-60	50-60	50-60	50-60
Power / kW	Depending on options	Depending on options	Depending on options	Depending on options

## BOOT DRYERS

### ELD DOUBLE-SIDED



The boot dryers dry the inside of the boots, shoes or clogs by means of an (optionally heated) air stream. Application of the optional ozone treatment kills bacteria and neutralises odours. Optionally available on castors.



ELD-30-2

Type	ELD-20/2	ELD-30/2	ELD-40/2
Article number	78000327	78000328	78000329
Capacity	40 pairs	60 pairs	80 pairs
Width / mm	1306	1826	2346
Depth / mm	700	700	700
Height / mm	1820	1820	1820
Voltage / VAC	1x 230	1x 230	1x 230
Frequency / Hz	50-60	50-60	50-60
Power / kW	Depending on options	Depending on options	Depending on options

## BOOT STORAGE RACKS

### ELR FLOOR MODEL



The boot storage racks are suitable for different quantities of boots, shoes and clogs.

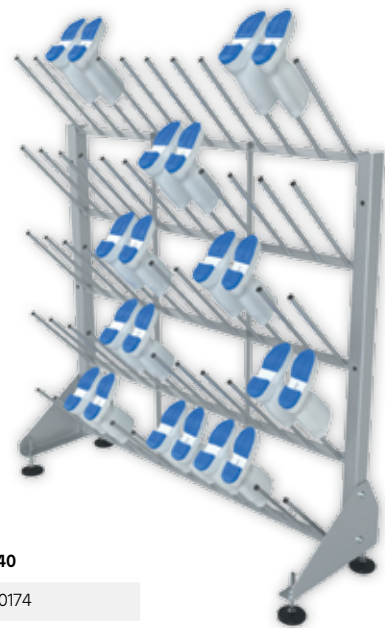

ELR-30 FLOOR MODEL

Type	ELR-10	ELR-20	ELR-30	ELR-40
Article number	78000152	78000145	78000160	78000174
Capacity	10 pairs	20 pairs	30 pairs	40 pairs
Width / mm	594	1114	1634	2154
Depth / mm	519	519	519	519
Height / mm	1830	1830	1830	1830

## BOOT STORAGE RACKS

### ELR WALL MODEL

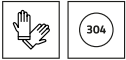

The boot storage racks are suitable for different quantities of boots, shoes and clogs.

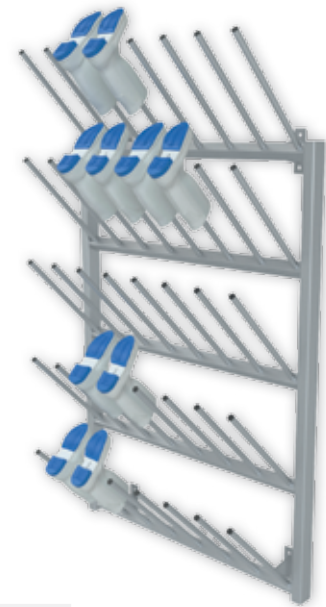

ELR-20 WALL MODEL

Type	ELR-10	ELR-20	ELR-30	ELR-40
Article number	78000153	78000146	78000170	78000173
Capacity	10 pairs	20 pairs	30 pairs	40 pairs
Width / mm	520	1040	1560	2080
Depth / mm	427	427	427	427
Height / mm	1808	1808	1808	1808

## BOOT STORAGE RACKS

### ELR DOUBLE-SIDED



The boot storage racks are suitable for different quantities of boots, shoes and clogs. Optionally available on castors.

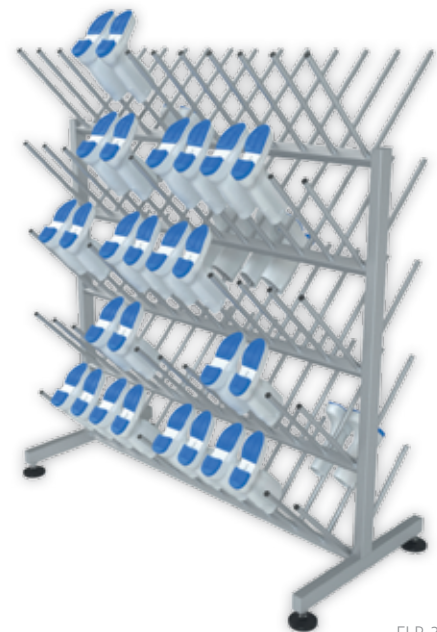

ELR-30/2

Type	ELR-20/2	ELR-30/2	ELR-40/2
Article number	78000148	78000180	78000182
Capacity	40 pairs	60 pairs	80 pairs
Width / mm	1114	1600	2346
Depth / mm	998	998	700
Height / mm	1830	1830	1830

## OPTION FOR BOOT DRYING AND STORAGE RACKS

### GLOVE HOLDER



The glove holder is intended for the drying or hanging up of sturdy rubber gloves.



<b>Type</b>	<b>GLOVE HOLDER</b>
Article number	78002308
Capacity	1 single glove

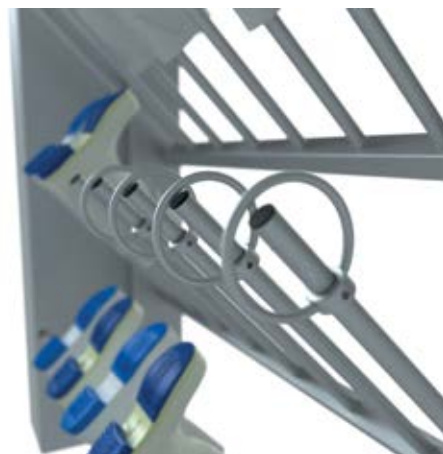

GLOVE HOLDER

## APRON RACK

### DOUBLE-SIDE



The apron rack can support 12 apron hangers. The rack is made from stainless steel and has an ergonomic design.

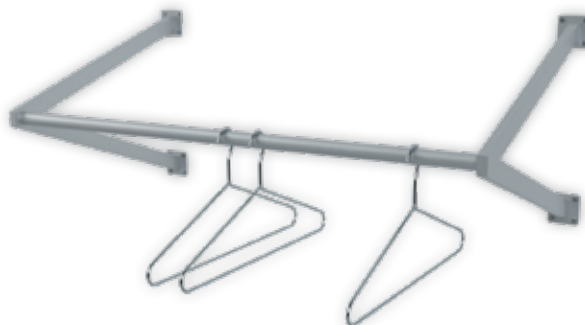

APRON RACK WALL MODEL

Type	APRON RACK FLOOR MODEL	APRON RACK WALL MODEL
Article number	78000355	78000361
Capacity	12 aprons	10 aprons
Width / mm	967	1190
Depth / mm	800	580
Height / mm	1845	471



# DRYING AND STORAGE RACKS

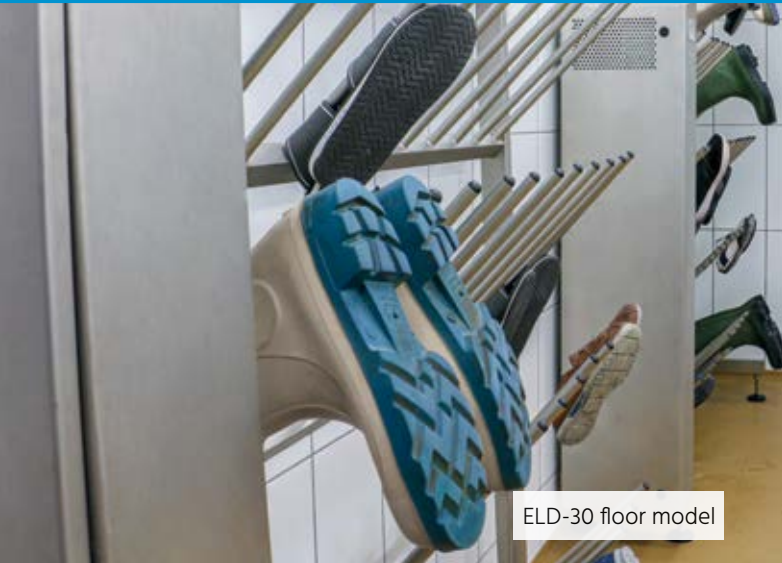

ELD-30 floor model



ELR-20 wall model



ELR-30 wall model



ELD-20 wall model



Apron rack wall model

# SOCIAL ROOM EQUIPMENT

## Guaranteed and effective hygiene

In addition to the complete installation of the hygienic entrance itself, the social area also deserves the necessary attention. This is where employees can change clothes and prepare to enter the hygiene lock and then the production area. It is important to organise this area practically so that employees do not get in each other's way, especially when changing shift. First of all, take a good look at how employees move through the area, what actions they take and what they need to achieve this. A logical layout can then be determined so that hygiene is guaranteed and the processes are carried out effectively.

## TURNSTILE

T



A turnstile from Elpress enables you to apply an enforced hygiene process before entering production areas. The model is available as a left-hand and right-hand version.



T-R

Type	T-R/L
Article number (R)	83201035
Article number (L)	83201045
Width / mm	1455
Depth / mm	791
Height / mm	1207
Voltage / VAC	1x 230
Frequency / Hz	50-60
Power / kW	0.1

## TURNSTILE WALL MODEL

### T-WM



A turnstile from Elpress enables you to apply an enforced hygiene process before entering production areas. This model is available as a wall model or floor model in combination with the floor-mounting frame. The model is available as a left-hand and right-hand version.



T-WM-R on a floor-mounting frame.

Type	T-WM-R/L	FLOOR-MOUNTING FRAME
Article number (R)	83201030	83201070
Article number (L)	83201040	-
Width / mm	890	400
Depth / mm	339	230
Height / mm	1229	1471
Voltage / VAC	1x 230	-
Frequency / Hz	50-60	-
Power / kW	0.1	-

## REVOLVING GATE

### EPDK



The EPDK is motorised, reducing the amount of contact needed to set it in motion. The access control is double-sided, allowing access to be granted in both directions. It is also possible to disconnect the motor and allow operation in both directions as required.

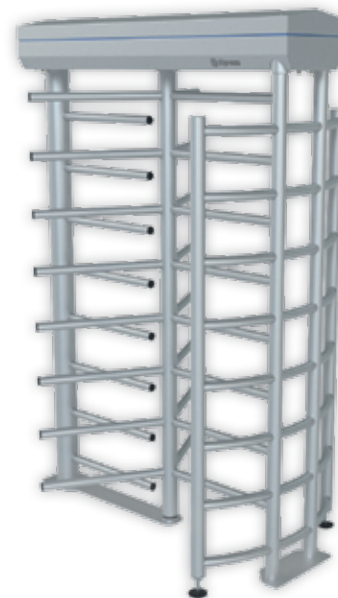

EPDK-3

Type	EPDK-3	EPDK-4
Article number	79000658	79000658
Capacity	3-armed	4-armed
Width / mm	1643	1643
Depth / mm	1361	1361
Height / mm	2313	2313
Voltage / VAC	1x 230	1x 230
Frequency / Hz	50-60	50-60
Power / kW	0.1	0.1

## SWING GATE WITH MAGNETIC LOCK

### SWING GATE



The swing gate is magnetically locked. The swing gate can be remotely unlocked by using a push button, for example.

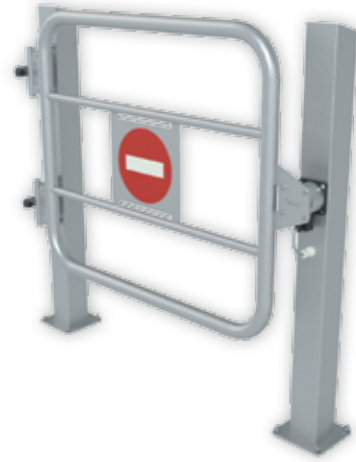

SWING GATE 1000

Type	SWING GATE 1000	SWING GATE 1100	SWING GATE 1200	SWING GATE 1300	SWING GATE 1400	SWING GATE 1500
Article number	79000659-1000	79000659-1100	79000659-1200	79000659-1300	79000659-1400	79000659-1500
Width / mm	1000	1100	1200	1300	1400	1500
Depth / mm	187	187	187	187	187	187
Height / mm	1020	1020	1020	1020	1020	1020
Passage Width / mm	776	876	976	1076	1176	1276
Voltage / VAC	1x 230	1x 230	1x 230	1x 230	1x 230	1x 230
Frequency / Hz	50-60	50-60	50-60	50-60	50-60	50-60
Power / kW	0.03	0.03	0.03	0.03	0.03	0.03

## BENCH

### STAINLESS STEEL BENCH

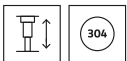

Our benches are produced with a stainless steel frame. This means a solid and hygienic construction with a white plastic surface for the user to sit on. The bench has adjustable feet and a shoe rack.



BENCH 1500

Type	BENCH 1000	BENCH 1500	BENCH 2000	BENCH 3000
Article number	78001312	78001314	78001315	78001316
Width / mm	350	350	350	350
Height / mm	420	420	420	420
Length / mm	1000	1500	2000	3000

## BENCH WITH COMPARTMENTS

### BENCH



Our benches are produced with a stainless steel frame. This means a solid and hygienic construction with a white plastic surface for the user to sit on. The bench has storage compartments for shoes.



BENCH 24

Type	BENCH 12	BENCH 24
Article number	78001322	78001321
Capacity	2x 6 shoe compartments	2x 12 shoe compartments
Width / mm	600	600
Height / mm	500	500
Length / mm	1000	2000

## COMPUTER CABINET

### COMPUTER CABINET



The Elpress computer cabinet is suitable for accommodating your computer needs. The cabinet can be moved about on the mounted swivel castors.



COMPUTER CABINET

Type	COMPUTER CABINET
Article number	78002271
Width / mm	1260
Depth / mm	915
Height / mm	1800

## STORAGE AND CLOTHING CABINETS

**FI**



The cabinets are made of stainless steel. The cabinets have adjustable feet and a slanting top. The cabinets are optionally available with a flat top.



FI-1013

Type	FI-2003	FI-1013	FI-1002-2
Article number	78001346	78001351	78001354
Capacity	2 compartments	2x 2 compartments	2x 2 compartments
Width / mm	950	950	350
Depth / mm	500	500	400
Height / mm	2160	2160	2000

## MULTI-COMPARTMENT CLOTHING CABINETS

**SP**

The cabinets are made of steel and have a rail for clothes hangers, a partition wall, storage shelf, ventilation slots and preparation for a name card. The standard colour is grey. The cabinets are optionally available with a slanting top and in 4 colours (RAL): blue, yellow, red and anthracite.



SP-222

Type	SP-111	SP-222	SP-333	SP-444
Article number	78200014	78200015	78200016	78200017
Capacity	1 persons / 2 compartments	2 persons / 4 compartments	3 persons / 6 compartments	4 persons / 8 compartments
Width / mm	322	615	907	1200
Depth / mm	500	500	500	500
Height / mm	1800	1800	1800	1800

## UNIVERSAL CLOTHING CABINETS

EP

The cabinets are made of steel and have a rail for clothes hangers, a partition wall, storage shelf, ventilation slots and preparation for a name card. The standard colour is grey. The cabinets are optionally available with a slanting top and in 4 colours (RAL): blue, yellow, red and anthracite.



EP-102

Type	EP-102	EP-104	EP-201	EP-202
Article number	78200005	78200007	78200008	78200009
Capacity	1 person / 2 compartments	4 persons / 4 compartments	1 person / 2 compartments	2 persons / 4 compartments
Width / mm	615	1200	420	810
Depth / mm	500	500	500	500
Height / mm	1800	1800	1800	1800

## WARDROBE WITH COMPARTMENTS

WARDROBE

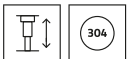

The wardrobe is made with a stainless steel frame. The legs are finished with adjustable feet for easy setting of the ideal height. The wardrobe has a good number of clothes hooks for a simple way to hang up clothing. The wardrobe also has 10 storage compartments.

Type	WARDROBE
Article number	78001323
Capacity	10 compartments
Width / mm	400
Height / mm	2310
Length / mm	1500



WARDROBE

# SOCIAL ROOM EQUIPMENT



SWING GATE 1000



Swing gate EPDK-4



Various BENCHES 24



BENCH 1500



T-R











Since 1976 ♥ for hygiene

**Elpress is the leading producer in the field of industrial hygiene. Our focus is on the delivery of total solutions: customer-focused products that are expertly integrated into your business process. By simplifying processes and sharing knowledge, we can add value to your business with a complete product package.**

Our years of experience have resulted in high-quality products. Their reliability and ease of use have already been proven in the field. With the wide range of possibilities offered by our products, we offer a solution for every challenge.

**We have a Passion for Hygiene!**

### **Elpress BV**

Handelstraat 21  
Industriegebied Saxe Gotha  
NL-5831 AV Boxmeer  
The Netherlands

T +31 (0)485 51 69 69  
E [sales@elpress.com](mailto:sales@elpress.com)  
W [www.elpress.com](http://www.elpress.com).



HYG - EN - 16022024

visit our website

**Elpress** | Personal Hygiene